



eldes

EWF1 WIRELESS
SMOKE DETECTOR

EWF1CO WIRELESS
SMOKE & CO DETECTOR

User manual v1.2

EWF1 compatible with:

- ESIM264 v7.11.30 and up + EWT1 16.14 and up.
- ESIM364 v02.04.01 and up.
- EPIR2 v01.01.02 and up.
- EPIR3 all versions.
- PITBULL EPIR3 all versions.

EWF1CO compatible with:

- ESIM364 v02.12.00 and up.
- EPIR3 v01.07.00 and up.
- PITBULL EPIR3 V02.02.00 and up.

Main features

- Photoelectric sensor for slow smouldering fires (EWF1) / Combined photoelectric and electrochemical sensor for slow smouldering fires and carbon monoxide (CO) detection (EWF1CO)
- TEST WEEKLY button
- Non-radioactive technology for environmental friendly
- High and stable sensitivity
- Quick fix mounting plate for easy installation
- LED operation indicator
- Built-in speaker for audio alarm indication
- Auto-reset when smoke clears

EWF1 is a wireless photoelectric-based smoke detector designed to detect smouldering fire before bursting into flame, while EWF1CO is a wireless electrochemical-based carbon monoxide (CO) detector combined with photoelectric-based smoke detector designed to detect smouldering fire. When the concentration of smoke/CO exceeds a given threshold, the system will cause resulting in built-in siren activation and SMS text message and phone call delivery (by default) to the listed user phone number. By default, when more than one EWF1/EWF1CO device is used, the system will automatically activate the interconnection feature. See **4.1. Interconnection**.

ESIM264, EPIR2 and EPIR3 alarm systems support up to 16 EWF1 devices, while ESIM364 - up to 32 EWF1 devices. Up to 16 EWF1CO can be connected to EPIR3 alarm system, while ESIM364 supports up to 32 EWF1CO devices. The maximum wireless connection range is 150m (492.13ft) (in open areas).

NOTE: EWF1 contains a smoke sensor solely, while EWF1CO contains a carbon monoxide (CO) sensor and a smoke sensor.

NOTE: For complete information on device operation with ELDES alarm system, please refer to ELDES alarm system installation manual located at www.eldes.lt/download

1. PACKAGE CONTENT

| Item | Quantity |
|--|----------|
| 1. EWF1/EWF1CO..... | 1 |
| 2. User manual..... | 1 |
| 3. Primary 9V Lithium 1200mAh battery..... | 1 |
| 4. Screws..... | 2 |

2. TECHNICAL SPECIFICATIONS

2.1. Electrical & Mechanical Characteristics

| | |
|--------------------------------------|--|
| Battery..... | Primary 9V Lithium 1604LC (ANSI/NEDA) |
| Number of batteries..... | 1 |
| Battery operation time..... | 18 months* |
| Wireless band..... | ISM868/ISM915 |
| Wireless communication range..... | Up to 30m (98.43ft) in premises; up to 150m (492.13ft) in open areas |
| Smoke detection type..... | Photoelectric chamber |
| Sensitivity to smoke..... | 3.0-5.0 % 0 bs/m |
| Carbon monoxide detection type..... | Electrochemical |
| Carbon monoxide detection range..... | 0-400 ppm |
| Alarm sound level..... | 85dB at 3m (85dB at 9.84ft) |
| EWF1 lifetime..... | 10 years |
| EWF1CO lifetime..... | 7 years |
| Range of operating temperatures..... | +5... +45°C (41... 113°F) |
| Humidity..... | 0-90% RH @ 0... +40°C (0-90% RH @ +32... +104°F) (non-condensing) |
| Dimensions..... | 110mm (4.33in) Ø |

* The specified operation time applies in case of no alarms and when having the device tested once a week. The operation time might vary in different conditions.

2.2. Main Unit & LED Functionality

| | |
|-------------|--|
| TEST WEEKLY | Button for testing the unit / restoring the zone |
| LED | EWF1/EWF1CO status indication |
| SIREN | Built-in speaker for audio alarm indication |
| RESET | Button for restoring default parameters |
| TAMPER | Tamper switch |

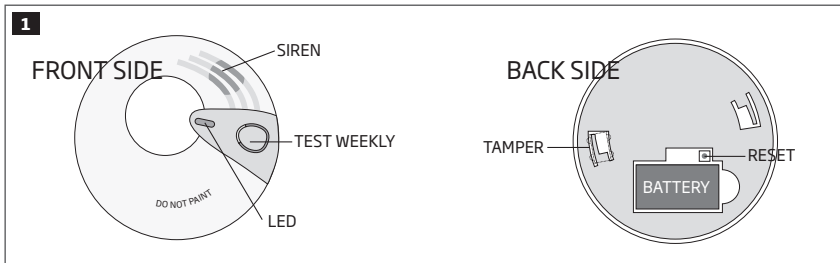

3. PLACEMENT

- Place the detector as close to the center of the ceiling as possible. If this is not practical, mount no closer than 10cm (0.33ft) from a wall or corner. Also, if local codes allow, install the detectors on walls, between 10 and 30cm (0.33 and 0.98ft) from ceiling/wall intersections.
- Install a minimum of two units in every house, no matter how small the house is.
- Place a detector in each room that is divided by a partial wall (either coming down from the ceiling at least 20cm (0.66ft), or coming up from the floor).

NOTE: For best protection we recommend that you install a detector in every room.

Recommended EWF1/EWF1CO placement locations

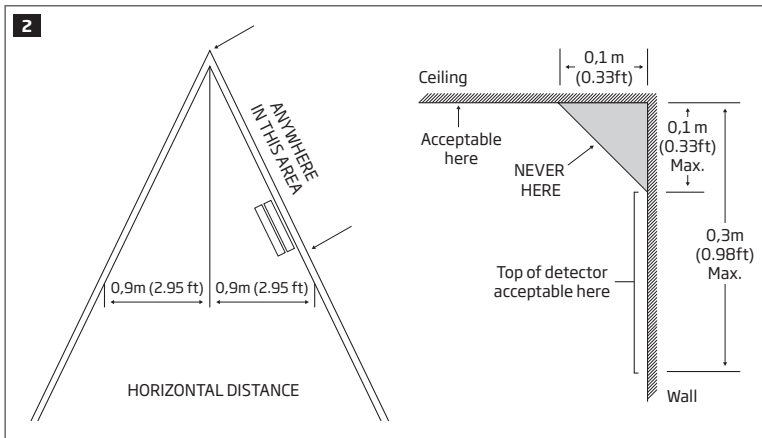

NOTE: Measurements shown are to the closest edge of the detector.

3.1. Typical Single-Story House

Install a detector on the ceiling or wall inside each bedroom and in the hallway outside each separate sleeping area. If a bedroom area hallway is more than 9m (29.53ft) long, install a detector at each end.

If there is a basement: Install a detector on the basement ceiling at the bottom of the stairwell.

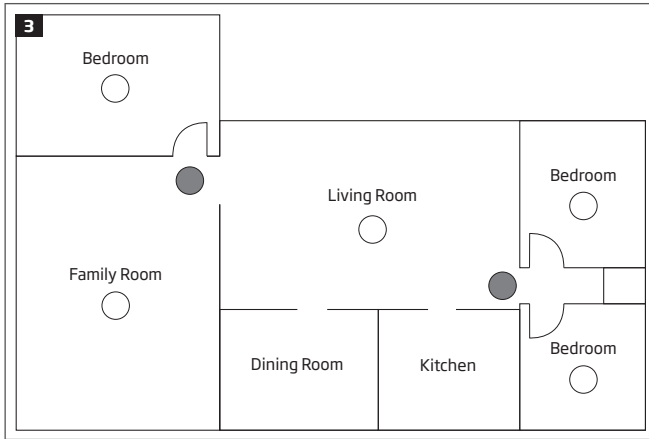

LEGEND:

- Minimum required smoke/CO detector locations.
- Recommended additional smoke/CO detector locations

3.2. Typical Multi-Story or Split-Level House

Install a detector on the ceiling or wall inside each bedroom and in the hallway outside each separate sleeping area. If a bedroom area hallway is more than 9m (29.53ft) long, install a detector at each end. Please install a detector on the top of a first-to-second floor stairwell.

LEGEND:

- Minimum required smoke/CO detector locations.
- Recommended additional smoke/CO detector locations

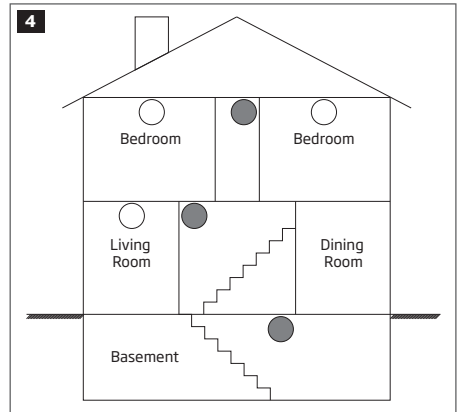

3.3. Incorrect EWF1/EWF1CO Placement

DO NOT place EWF1/EWF1CO in the following locations:

- Near appliances or areas where normal combustion regularly occurs (kitchens, near furnaces, hot water heaters). Use specialized detector with unwanted alarm control for this areas.
- In areas with high humidity, like bathrooms or areas near dishwashers or washing machines. Install at least 3m (9.84ft) away from these areas.
- Near air returns or heating and cooling supply vents. Install at least 1m (3.28ft) away from these areas. The air could blow smoke away from the detector, interrupting its alarm.
- In rooms where temperatures may fall below +5°C (+41°F) or rise above +45°C (+113°F).
- In extremely dusty, dirty, or insect-infested areas where loose particles interfere with the detector operation.

ATTENTION: Incorrect placement will result in a decrease of operational effectiveness.

3.4. Carbon Monoxide (CO) Poisoning

Carbon monoxide is a product of incomplete combustion of organic matter. It is a toxic gas, but, being colorless, odorless, tasteless, and initially non-irritating, it is very difficult for people to detect.

| CONCENTRATION | SYMPTOMS |
|-------------------|---|
| 35 ppm (0.0035%) | Headache and dizziness within six to eight hours of constant exposure |
| 100 ppm (0.01%) | Slight headache in two to three hours |
| 200 ppm (0.02%) | Slight headache within two to three hours; loss of judgment |
| 400 ppm (0.04%) | Frontal headache within one to two hours |
| 800 ppm (0.08%) | Dizziness, nausea, and convulsions within 45 min; insensible within 2 hours |
| 1,600 ppm (0.16%) | Headache, increased heart rate, dizziness, and nausea within 20 min; death in less than 2 hours |

ppm - Parts Per Million - is used to describe concentrations of contaminants in air.

3.5. Actions to Take In the Event of CO Alarm

In the event of ALARM caused by a critical CO concentration level, keep calm and carry out the following actions in the priority order:

- Open all windows and doors to increase the rate of ventilation.
- Turn off the appliances and stop using them where possible.
- Evacuate the building leaving the windows and doors open. You may re-enter the property only when the alarm has stopped.
- Get immediate medical assistance for anyone suffering the effects of carbon monoxide poisoning (nausea, headache), and report that carbon monoxide inhalation is suspected.
- Contact the gas or other fuel supplier on their emergency phone number in order to identify and eliminate the source of carbon monoxide emissions.
- Do not use the appliance again until it has been verified and confirmed by a competent person according to national regulations.

ATTENTION: Another source of carbon monoxide emission might be present apart from fuel-burning appliances, such as large amount of city gas, tobacco smoke or smouldering fire emissions.

3.6. CO Alarm/Restore and Fault Indications

- **Fresh air level** - when CO concentration is 0-29ppm. This level causes no alarm when reached as well as it results in zone restore event when one of the critical levels has been reached and decreased to 0-29ppm afterwards. The zone restore event is indicated by SMS text message delivered to the listed user phone number and data message delivered to the monitoring station followed by silenced sirens.
- **CO critical level 1** - when CO concentration of 30-49ppm remains for more than 120 minutes. Indicated by fault indication displayed by EKB2 LCD keypad (only for ESIM364) and a warning delivery to the listed user by SMS text message. This level causes no zone alarm when reached as well as it results in zone restore event in case the CO concentration of 300ppm or more (critical level 4) has been reached and decreased to 30-49ppm afterwards.
- **CO critical level 2** - when CO concentration of 50-99ppm remains for more than 60 minutes. Indicated by a 2-second beep every 5 seconds, LED indicator flash, fault indication displayed by EKB2 LCD keypad (only for ESIM364) and a warning delivered to the listed user by SMS text message. This level causes no zone alarm when reached.
- **CO critical level 3** - when CO concentration of 100-299ppm remains for more than 10 minutes. Indicated by a 2-second beep every 5 seconds, LED indicator flash and fault indication displayed by EKB2 LCD keypad (only for ESIM364) and a warning delivered to the listed user by SMS text message. This level causes no zone alarm when reached.
- **CO critical level 4** - when CO concentration of 300ppm and more is reached. This level will cause an alarm when reached resulting in the unit emitting a 2-second beep every 5 seconds and LED indicator flash. Meanwhile the system will notify the listed user by SMS text message and the monitoring station as well as all wired and wireless sirens will emit a pulsating sound based on the Fire-type zone operational description and activate the interconnection feature (by default - enabled; see **4.1. Interconnection**). All wired and wireless sirens can be silenced by disarming the system. However, EWF1CO built-in siren will remain active until the TEST WEEKLY button has been pressed.
- **CO unit fault** - when CO sensor lifetime has ended within a 7-year period or in case of any technical issue that has occurred. Indicated by fault indication displayed by EKB2 LCD keypad (only for ESIM364) and notification delivery to the listed user by SMS text message and the monitoring station. Please contact your local supplier for repair service.

4. INSTALLATION

NOTE: Before installing the wireless device, we highly recommend to refer to **RADIO SYSTEM INSTALLATION AND SIGNAL PENETRATION** manual located at www.eldes.lt/download

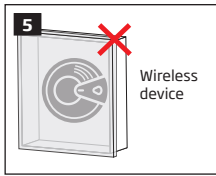

Never install in the following locations:

- inside the metal cabinet
- closer than 20cm (7.87in) from the metal surface and/or power lines

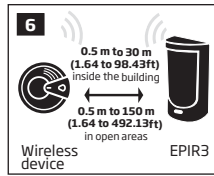

Recommended:

- face the front side of the wireless device towards the front side of the antenna.
- keep the distance: 0,5 to 30m (1.64 to 98.43ft) inside the building, 0,5 to 150m (1.64 to 492.13ft) in open areas

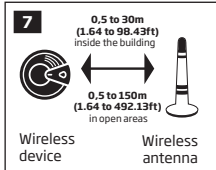

Recommended:

- face the front side of the wireless device towards the antenna.
- keep the distance: 0,5 to 30m (1.64 to 98.43ft) inside the building, 0,5 to 150m (1.64 to 492.13ft) in open areas

1. Detach the mounting plate by turning it counter-clockwise from the back of EWF1/EWF1CO (see Fig. No. 8).
2. Secure the mounting plate to ceiling or wall with mounting screws.(see Fig. No. 8).
3. Lift to open the battery pocket door (see Fig. No. 10)
4. Insert the battery into the battery pocket considering the polarity terminals indicated on the enclosure of EWF1/EWF1CO. Ensure the battery is securely connected. Red LED may flash briefly when the battery is being installed.
5. Close the battery pocket door by snapping it into place.
6. Position the smoke detector to the mounting plate by turning it clockwise to lock into place. Note that the device will not lock into the mounting plate without the battery being present in the battery pocket.
7. Push the TEST WEEKLY button to verify if the wireless smoke detector is operational. See **4.1. Testing EWF1**.
8. Bind the device to the alarm system using *ELDES Configuration Tool* software. Open **Wireless Device Management** section and enter a 8-digit wireless device ID located on the EWF1/EWF1CO enclosure and click the **Add** button (see Fig. No. 9). The device can also be bind by sending a corresponding command via SMS text message. For more details, please refer to the software's HELP section and ELDES alarm system installation manual.
9. Upon the successful binding process, EWF1/EWF1CO device icon becomes visible in **Wireless Device Management** section as well as Battery Level and Signal Level (see Fig. No. 9).
10. EWF1/EWF1CO device is ready for use.

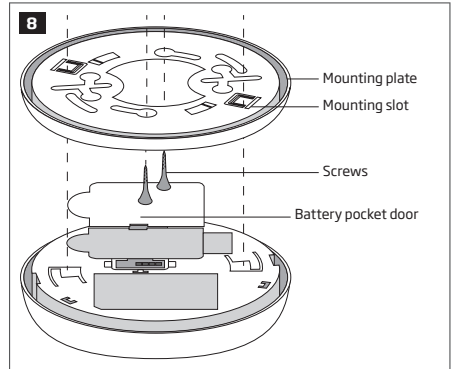

NOTE: If you are unable to bind the wireless device, please restore the parameters of the wireless device to default and try again. See chapter **5.3. Restoring Default Parameters** for more details.



4.1. Interconnection

The interconnection feature automatically links all wireless detectors that are paired with the alarm system. When any EWF1/EWF1CO detects smoke/CO, it will sound the built-in siren and send the signal to the alarm system resulting in an instant alarm followed by built-in siren sound caused by the rest of EWF1/EWF1CO devices. EWF1/EWF1CO device that detected smoke will auto-reset when the smoke clears, while the rest of EWF1/EWF1CO devices will continue to sound in accordance with the set time period (by default - 30 seconds) that can be managed by *ELDES Configuration Tool* software.

NOTE for EWF1CO: Interconnection will commence when CO critical level 4 has been reached (see 3.5. CO Alarm/Restore and Fault Indications)

5. MAINTENANCE

5.1. Testing the Unit

- The TEST WEEKLY button verifies if EWF1/EWF1CO is operational. Firmly push the TEST WEEKLY button and the detector will sound a loud beep. The alarm will stop sounding after releasing the TEST WEEKLY button. When testing EWF1/EWF1CO using *ELDES Configuration Tool* software, the detector will provide short beeps.
- The CO self-test on EWF1CO will be carried out by pushing the TEST WEEKLY button at carbon monoxide concentration below 30ppm. The button release will be followed by a built-in siren sound after a 10-second period:
 - Successful test - 5 beeps each lasting for 100 ms.
 - Failed test - 1 beep lasting for 1 sec. Please contact your local supplier for repair service.
- Stand at arm's length from the detector when testing.
- Test the detectors weekly and upon returning from vacation or when no one has been in the household for several days.
- Test each detector to be sure it is installed correctly and operating properly.
- DO NOT use an open flame to test this detector. You may ignite and damage the detector or your home.
- If the detector does not sound, please check the battery and signal level using *ELDES Configuration Tool* software.

ATTENTION: Test all detectors weekly to ensure proper operation.

NOTE: CO self-test is possible only after more than 3 minutes of EWF1CO runtime.

5.2. Battery Replacement

1. Turn EWF1/EWF1CO counter-clockwise to detach it from the mounting plate.
2. Gently pull down the device.
3. Remove the old battery from the battery pocket.
4. Position the new 9V battery according to the appropriate battery slot positive/negative terminals indicated on the enclosure of EWF1/EWF1CO. Ensure the plastic battery holder is fully depressed when the battery has been fitted.
5. Using the TEST WEEKLY button, test the detector to verify if it is operational. See **4.1. Testing the Unit**.
6. Re-attach EWF1/EWF1CO to the mounting plate by turning the device clockwise until it snaps into place.

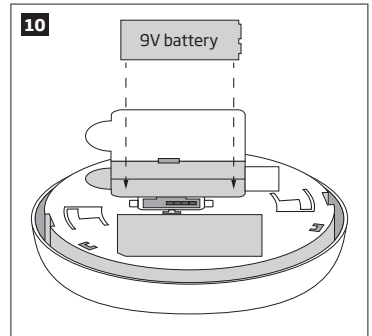

ATTENTION: Only Primary 9V Lithium 1200mAh battery can be used. Install only new, high quality and unexpired batteries.

ATTENTION: The battery must be removed if the device is not in use.

ATTENTION: In order to avoid fire or explosion hazards, the system must be used only with approved battery. Special care must be taken when connecting positive and negative battery terminals. Dispose old batteries only into special collection sites. Do not charge, disassemble, heat or incinerate old batteries.

NOTE: The battery status can be monitored in real-time using *ELDES Configuration Tool* software.

NOTE: The system sends an SMS message to the listed user phone number as soon as the battery level runs below 5%.

NOTE: We strongly recommend using EVE CR9V-P or Energizer LA522 battery.

5.3. Restoring Default Parameters

1. Remove the battery from EWF1/EWF1CO.
2. Press and hold the RESET button.
3. Insert the battery back to EWF1/EWF1CO.
4. Hold the RESET button until you hear a short beep.
5. Release the RESET button.

5.4. Cleaning and Precautions During Use

Clean the detector at least once a month to remove dust, dirt, or debris. Using the soft brush or wand attachment of a vacuum cleaner, vacuum all sides and cover of the detector. Be sure all the vents are free of debris. If necessary, use a damp cloth to clean the detector cover. Some household substances can affect the sensitivity of the detectors in a short or long term. Avoid the use of model paint, model glue or nail polish remover close to the alarm. Do not use aerosol sprays, household cleaners, polishes or perfumes close to the device.

NOTE: Do not attempt to remove the cover to clean inside the detector. This will void your warranty.

6. EWF1/EWF1CO ZONE AND TAMPER

Upon successful device pairing process, the system adds wireless zone (-s) as follows:

- **EWF1** - 1 Fire-type zone intended for smoldering fire/smoke detection.
- **EWF1CO** - 1 Fire-type and 1 CO-type zone intended for smoldering fire/smoke detection and carbon monoxide detection respectively.

In case of tamper violation, the alarm is caused regardless of system being armed or disarmed. There are 2 ways to detect tamper violation on EWF1/EWF1CO:

- **By tamper switch.** EWF1/EWF1CO comes equipped with a built-in tamper switch intended for enclosure supervision: The tamper switch is located on the back of the PCB supervising the back side of the enclosure in case the device is illegally detached (see Fig. No. 1). Once the enclosure of EWF1/EWF1CO is tampered, the tamper switch will become triggered. This action will be followed by alarm, resulting in sending an SMS text message and/or phone call to the user. The SMS text message contains the violated tamper name.
- **By wireless connection loss.** The wireless connection loss between EWF1 and ELDES alarm system leads to alarm. The system identifies this event as a tamper violation and sends alarm by SMS text message and phone call to the user (-s) by default. The SMS text message contains the wireless device model, wireless ID code and tamper name. The user will also be notified by SMS text message as soon as the wireless signal is restored.

ATTENTION: The tamper will not operate if the wireless zone (-s) is disabled.

7. TEMPERATURE SENSOR

The device comes equipped with a built-in temperature sensor allowing to monitor the temperature of the area surrounding EWF1/EWF1CO device. When using the with EPIR3 alarm system, you may set the MIN and MAX temperature thresholds ranging from +5°C to +45°C resulting in SMS text message delivery to the listed user phone number once exceeded. The accuracy of temperature measurement is +/-1°C.

8. ADDITIONAL INFORMATION

Limited Liability

The buyer must agree that the system will reduce the risk of fire, theft, burglary or other dangers but does not guarantee against such events. "ELDES UAB" will not take any responsibility regarding personal or property or revenue loss while using the system. "ELDES UAB" liability according to local laws does not exceed value of the purchased system. "ELDES UAB" is not affiliated with any of the Internet providers therefore is not responsible for the quality of Internet service.

Manufacturer Warranty

This device carries a 24-month warranty by the manufacturer "ELDES UAB". Warranty period starts from the day the system has been purchased by the end user. The warranty is valid only if the system has been used as intended, following all guidelines listed in the manual and within specified operating conditions. Receipt must be kept as a proof of purchase date. The warranty is voided if the system has been exposed to mechanical impact, chemicals, high humidity, fluids, corrosive and hazardous environment or other force majeure factors.

Safety instructions

Please read and follow these safety guidelines in order to maintain safety of operators and people around:

- DO NOT use the system where it can be interfere with other devices and cause any potential danger.
- DO NOT use the system with medical devices.
- DO NOT use the system in hazardous environment.
- DO NOT expose the system to high humidity, chemical environment or mechanical impacts.
- DO NOT attempt to personally repair the system.

ELDES UAB,

Ukmerges st. 283B,

Vilnius, Lithuania

EN14604:2005

Smoke, carbon monoxide alarm

EWf1/EWf1CO



The WEEE (Waste Electrical and Electronic Equipment) marking on this product (see left) or its documentation indicates that the product must not be disposed of together with household waste. To prevent possible harm to human health and/or the environment, the product must be disposed of in an approved and environmentally safe recycling process. For further information on how to dispose of this product correctly, contact the system supplier, or the local authority responsible for waste disposal in your area.

Copyright © "ELDES UAB", 2015. All rights reserved

It is not allowed to copy and distribute information in this document or pass to a third party without advanced written authorization by "ELDES UAB". "ELDES UAB" reserves the right to update or modify this document and/or related products without a warning. Hereby, "ELDES UAB" declares that wireless smoke/CO detector EWf1/EWf1CO is in compliance with the essential requirements and other relevant provisions of Directive 1999/5/EC. The declaration of conformity may be consulted at www.eldes.lt



Made in the European Union
www.eldes.it